

LX1 High Density LGX 1.5U Patch Panel

An innovative 1.5U, 19" rack mountable patch panel, designed for use in high density applications. It offers management of up to 72 fibres using MTP® optical cassettes with 24 fibres each and it's fully compatible with a variety of alternative LGX module options.

When used for fusion splicing it can house up to 24 fibres, using 2 x12 fibre splice trays and the customer can choose from a wide variety of adaptor loaded LGX plates.

The MLX1 LGX MTP® modules which are compatible with LX1 panel are designed for the transition between MTP® and standard LC connectors. They have a small form factor design and LX1 panel can house up to 3 MLX1 modules in 1U height. They come with 12 low loss LC duplex adaptors on the front and 2 MTP® on the back side. They contain 100% factory terminated and tested LC to MTP® fanouts.

Features

- 1.5U height
- 19" rack mountable
- Up to 3 LGX modules
- Compatible with 12 fibre splice trays
- Up to 72 fibres with MTP® and 24 with standard adaptors
- Metal construction
- Compatible with multiple LGX module options (MTP®, adaptors, etc.)

Applications

- Data centres
- High density applications
- Telecommunication networks
- Enterprise Networks
- Central Offices

Specifications

Patch Panel

ELEMENT	CHARACTERISTIC
Depth (mm) A	326.5mm
Width (mm) B	438mm
Height (mm) C	69.7mm
Rack Units	1.5
Capacity	3 x LGX type modules

MTP® Connector Performance

CONNECTOR MATING	IL AVERAGE	IL MAX	RETURN LOSS
MTP® Elite (MM)	0.10dB	0.35dB	N/A
MTP® (MM)	0.20dB	0.60dB	N/A
MTP® Elite (SM)	0.10dB	0.35dB	>60dB
MTP® (SM)	0.25dB	0.75dB	>60dB

Standards Compliance

- TIA/EIA-568-C.3 and ISO/IEC 11801 - cable
- IEC-61754-7 & EIA/TIA-604-5 - MTP®
- Compliant to Directive 2002/95/EC (RoHS) and REACH SvHC
- IEC-61754-20 (LC) & IEC-61754-14 (SC)
- IEC-60793

Ordering Information

DESCRIPTION	PART NUMBER
Optronics LX1 High Density LGX 1.5U Patch Panel Unloaded	OPPLX1-XX-XX-UL-1.5
Splice Tray For 12 Heatshrink Splice Protectors	OFMST12-LX1
Blank LGX Plate	OPLXBL-2
Empty LGX Plate For 8 x SC Simplex/LC Duplex Adaptors	OPLX1-XX-XX-UL
Empty LGX Plate For 12 x SC Simplex/LC Duplex Adaptors	OPLX2-XX-XX-UL
Empty LGX Plate For 3 x SC Duplex/LC Quad Adaptors	OPLX3-XX-XX-UL
Empty LGX Plate For 6 x SC Duplex/LC Quad Adaptors	OPLX4-XX-XX-UL
Empty LGX Plate For 8 x LC Simplex Adaptors	OPLX5-XX-XX-UL
Empty LGX Plate For 12 x LC Simplex Adaptors	OPLX6-XX-XX-UL
Empty LGX Plate For 8 x ST/FC Simplex Adaptors	OPLX7-XX-XX-UL
Empty LGX Plate For 12 x ST/FC Simplex Adaptors	OPLX8-XX-XX-UL

LC LGX Plates configuration

DESCRIPTION	PART NUMBER
LGX Plate with 8 x LC Simplex Multimode Beige Adaptors	OPLX5-00-21-08
LGX Plate with 8 x LC Simplex Multimode OM3 Aqua Adaptors	OPLX5-00-31-08
LGX Plate with 8 x LC Simplex Multimode OM4 Erika Violet Adaptors	OPLX5-00-41-08
LGX Plate with 8 x LC Simplex Singlemode Blue Adaptors	OPLX5-00-91-08
LGX Plate with 8 x LC Simplex Singlemode APC Green Adaptors	OPLX5-00-91-08
LGX Plate with 12 x LC Simplex Multimode Beige Adaptors	OPLX6-00-21-12
LGX Plate with 12 x LC Simplex Multimode OM3 Aqua Adaptors	OPLX6-00-31-12
LGX Plate with 12 x LC Simplex Multimode OM4 Erika Violet Adaptors	OPLX6-00-41-12
LGX Plate with 12 x LC Simplex Singlemode Blue Adaptors	OPLX6-00-91-12
LGX Plate with 12 x LC Simplex Singlemode APC Green Adaptors	OPLX6-01-91-12
LGX Plate with 8 x LC Duplex Multimode Beige Adaptors	OPLX1-00-22-08
LGX Plate with 8 x LC Duplex Multimode OM3 Aqua Adaptors	OPLX1-00-32-08
LGX Plate with 8 x LC Duplex Multimode OM4 Erika Violet Adaptors	OPLX1-00-42-08
LGX Plate with 8 x LC Duplex Singlemode Blue Adaptors	OPLX1-00-92-08
LGX Plate with 8 x LC Duplex Singlemode APC Green Adaptors	OPLX1-01-92-08
LGX Plate with 12 x LC Duplex Multimode Beige Adaptors	OPLX2-00-22-12

LGX Plate with 12 x LC Duplex Multimode OM ₃ Aqua Adaptors	OPLX2-00-32-12
LGX Plate with 12 x LC Duplex Multimode OM ₄ Erika Violet Adaptors	OPLX2-00-42-12
LGX Plate with 12 x LC Duplex Singlemode Blue Adaptors	OPLX2-00-92-12
LGX Plate with 12 x LC Duplex Singlemode APC Green Adaptors	OPLX2-01-92-12
LGX Plate with 3 x LC Quad Multimode Beige Adaptors	OPLX3-00-24-03
LGX Plate with 3 x LC Quad Multimode OM ₃ Aqua Adaptors	OPLX3-00-34-03
LGX Plate with 3 x LC Quad Multimode OM ₄ Erika Violet Adaptors	OPLX3-00-44-03
LGX Plate with 3 x LC Quad Singlemode Blue Adaptors	OPLX3-00-94-03
LGX Plate with 3 x LC Quad Singlemode APC Green Adaptors	OPLX3-01-94-03
LGX Plate with 6 x LC Quad Multimode Beige Adaptors	OPLX4-00-24-06
LGX Plate with 6 x LC Quad Multimode OM ₃ Aqua Adaptors	OPLX4-00-34-06
LGX Plate with 6 x LC Quad Multimode OM ₄ Erika Violet Adaptors	OPLX4-00-44-06
LGX Plate with 6 x LC Quad Singlemode Blue Adaptors	OPLX4-00-94-06
LGX Plate with 6 x LC Quad Singlemode APC Green Adaptors	OPLX4-01-94-06

SC LGX Plates configuration

DESCRIPTION	PART NUMBER
LGX Plate with 8 x SC Simplex Multimode Beige Adaptors	OPLX1-02-21-08
LGX Plate with 8 x SC Simplex Multimode OM ₃ Aqua Adaptors	OPLX1-02-31-08
LGX Plate with 8 x SC Simplex Multimode OM ₄ Erika Violet Adaptors	OPLX1-02-41-08
LGX Plate with 8 x SC Simplex Singlemode Blue Adaptors	OPLX1-02-91-08
LGX Plate with 8 x SC Simplex Singlemode APC Green Adaptors	OPLX1-03-91-08
LGX Plate with 12 x SC Simplex Multimode Beige Adaptors	OPLX2-02-21-12
LGX Plate with 12 x SC Simplex Multimode OM ₃ Aqua Adaptors	OPLX2-02-31-12
LGX Plate with 12 x SC Simplex Multimode OM ₄ Erika Violet Adaptors	OPLX2-02-41-12
LGX Plate with 12 x SC Simplex Singlemode Blue Adaptors	OPLX2-02-91-12
LGX Plate with 12 x SC Simplex Singlemode APC Green Adaptors	OPLX2-03-91-12
LGX Plate with 3 x SC Duplex Multimode Beige Adaptors	OPLX3-02-22-03
LGX Plate with 3 x SC Duplex Multimode OM ₃ Aqua Adaptors	OPLX3-02-32-03
LGX Plate with 3 x SC Duplex Multimode OM ₄ Erika Violet Adaptors	OPLX3-02-42-03
LGX Plate with 3 x SC Duplex Singlemode Blue Adaptors	OPLX3-02-92-03
LGX Plate with 3 x SC Duplex Singlemode APC Green Adaptors	OPLX3-03-92-03
LGX Plate with 6 x SC Duplex Multimode Beige Adaptors	OPLX4-02-22-06

LGX Plate with 6 x SC Duplex Multimode OM ₃ Aqua Adaptors	OPLX4-02-32-06
LGX Plate with 6 x SC Duplex Multimode OM ₄ Erika Violet Adaptors	OPLX4-02-42-06
LGX Plate with 6 x SC Duplex Singlemode Blue Adaptors	OPLX4-02-92-06
LGX Plate with 6 x SC Duplex Singlemode APC Green Adaptors	OPLX4-03-92-06

FC LGX Plates configuration

DESCRIPTION	PART NUMBER
LGX Plate with 8 x FC Simplex Multimode Adaptors	OPLX7-05-21-08
LGX Plate with 8 x FC Simplex Singlemode Adaptors	OPLX7-05-91-08
LGX Plate with 8 x FC Simplex Singlemode APC Adaptors	OPLX7-06-91-08
LGX Plate with 12 x FC Simplex Multimode Adaptors	OPLX8-05-21-12
LGX Plate with 12 x FC Simplex Singlemode Adaptors	OPLX8-05-91-12
LGX Plate with 12 x FC Simplex Singlemode APC Adaptors	OPLX8-06-91-12

ST LGX Plates configuration

DESCRIPTION	PART NUMBER
LGX Plate with 8 x ST Simplex Multimode Adaptors	OPLX7-04-21-08
LGX Plate with 8 x ST Simplex Singlemode Adaptors	OPLX7-04-91-08
LGX Plate with 12 x ST Simplex Multimode Adaptors	OPLX8-04-21-12
LGX Plate with 12 x ST Simplex Singlemode Adaptors	OPLX8-04-91-12

MLX1 MTP® Cassette Module

DESCRIPTION	PART NUMBER
OptronicsPlus LC to MTP® Male MLX ₃ LGX Cassette Module with 12 LC Duplex OM ₃ Aqua Adaptors Polarity A	OMLX1-20003212-A
OptronicsPlus LC to MTP® Male Elite MLX ₁ LGX Cassette Module with 12 LC Duplex OM ₃ Aqua Adaptors Polarity A	OMLX1-24003212-A
OptronicsPlus LC to MTP® Male MLX ₁ LGX Cassette Module with 12 LC Duplex OM ₄ Erika Violet Adaptors Polarity A	OMLX1-20004212-A
OptronicsPlus LC to MTP® Male Elite MLX ₁ LGX Cassette Module with 12 LC Duplex OM ₄ Erika Violet Adaptors Polarity A	OMLX1-24004212-A
OptronicsPlus LC to MTP® Male MLX ₁ LGX Cassette Module with 12 LC Duplex SM Blue Adaptors Polarity A	OMLX1-20009212-A
OptronicsPlus LC to MTP® Male Elite MLX ₁ LGX Cassette Module with 12 LC Duplex SM Blue Adaptors Polarity A	OMLX1-24009212-A
OptronicsPlus LC to MTP® Male MLX ₁ LGX Cassette Module with 12 LC Duplex SM APC Green Adaptors Polarity A	OMLX1-20019212-A
OptronicsPlus LC to MTP® Male Elite MLX ₁ LGX Cassette Module with 12 LC Duplex SM Green Adaptors Polarity A	OMLX1-24019212-A

For polarity B or C please change the last letter of the part numbers above.

Technical Drawing

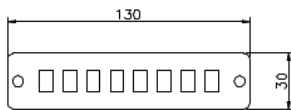
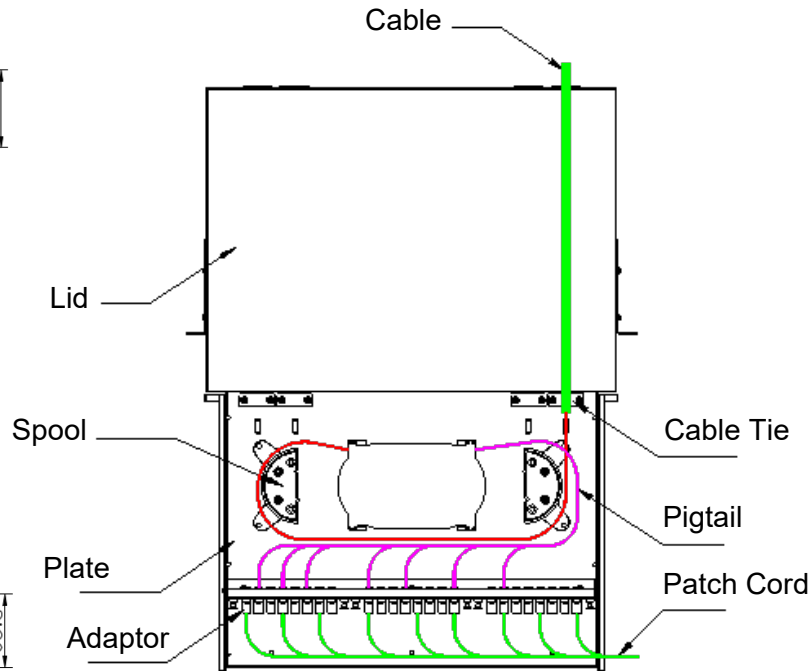
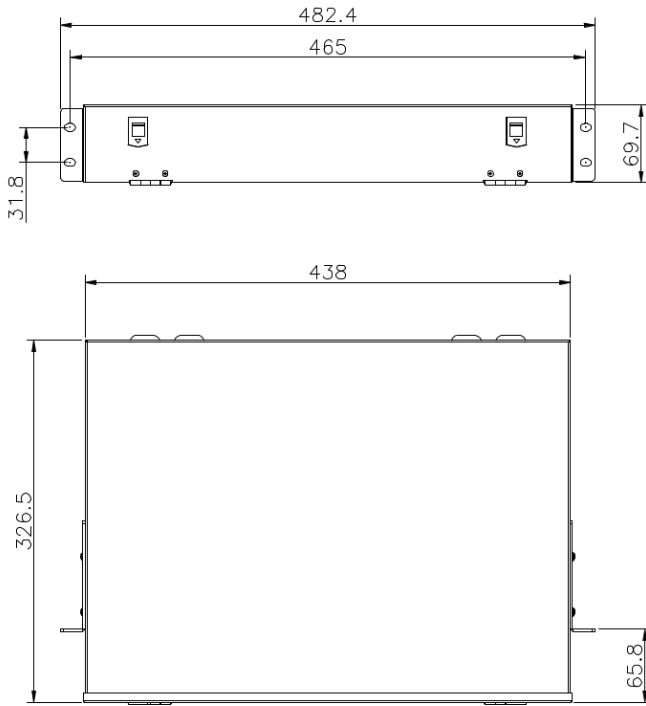
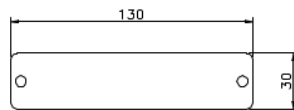

Plate for 8-LC Simplex adaptor



Blank Plate

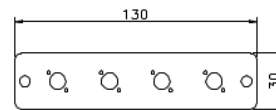

Plate for 4 FC simplex adaptor

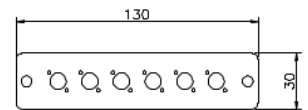

Plate for 6 FC simplex adaptor

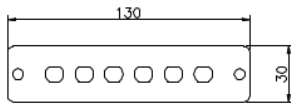

Plate for 6 ST simplex adaptor

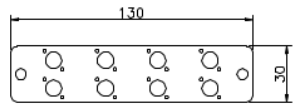

Plate for 8 FC simplex adaptor

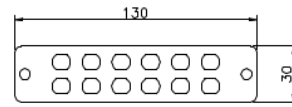

Plate for 12 FC simplex D type adaptor

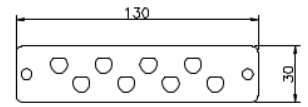

Plate for 8 FC simplex D type adaptor

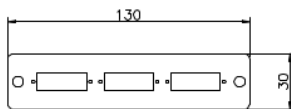

Plate for 3 SC duplex adaptor

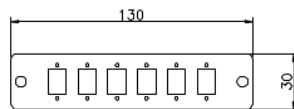

Plate for 6 SC simplex adaptor

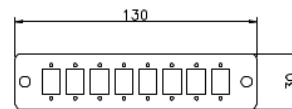
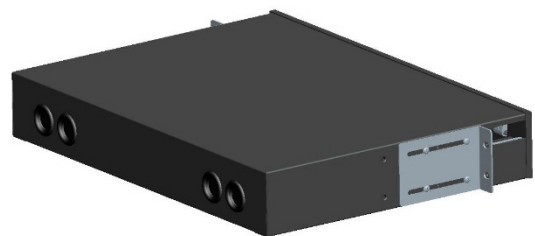
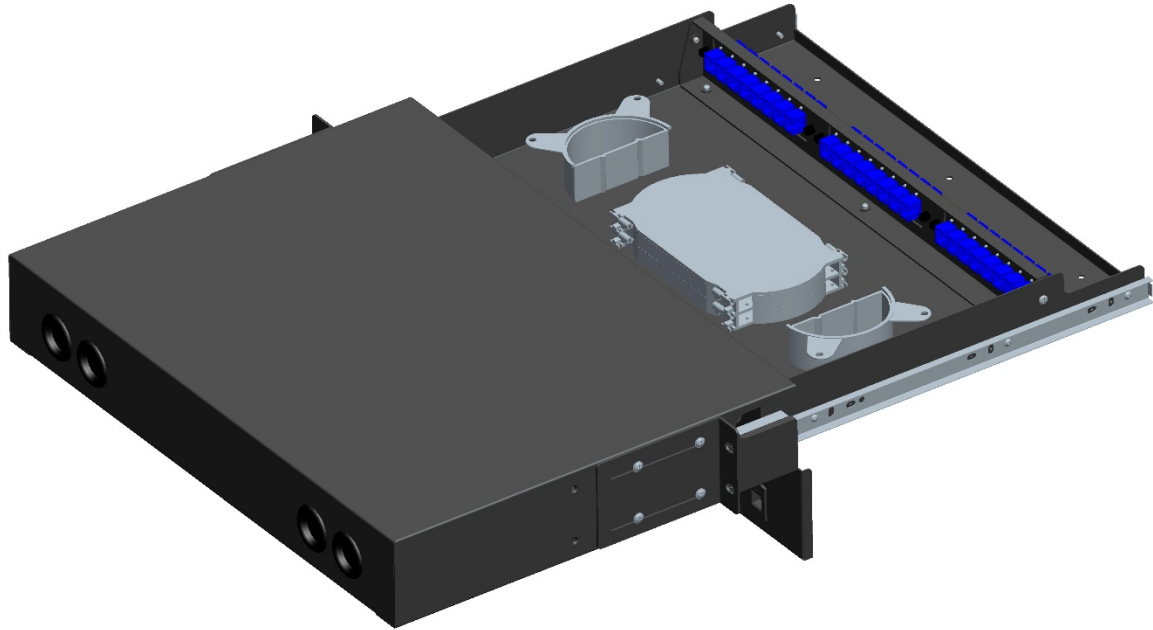

Plate for 8 SC simplex adaptor

Additional Images

Patch Panel



MTP® LGX Cassette Module

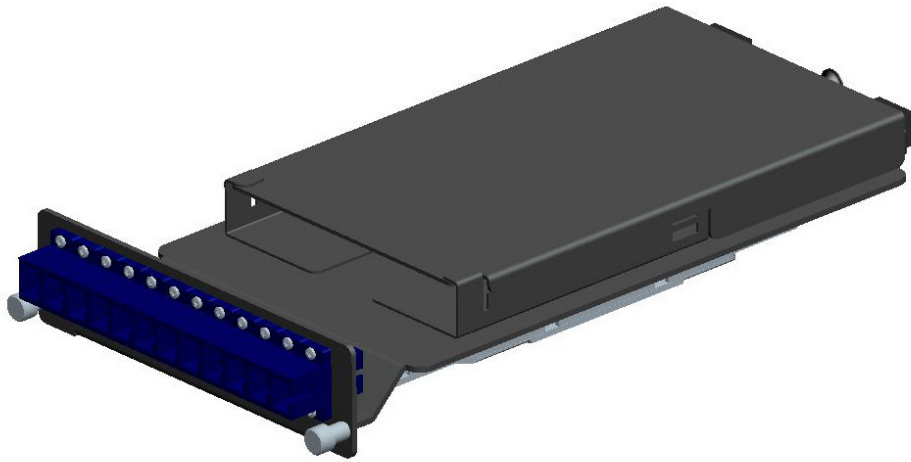
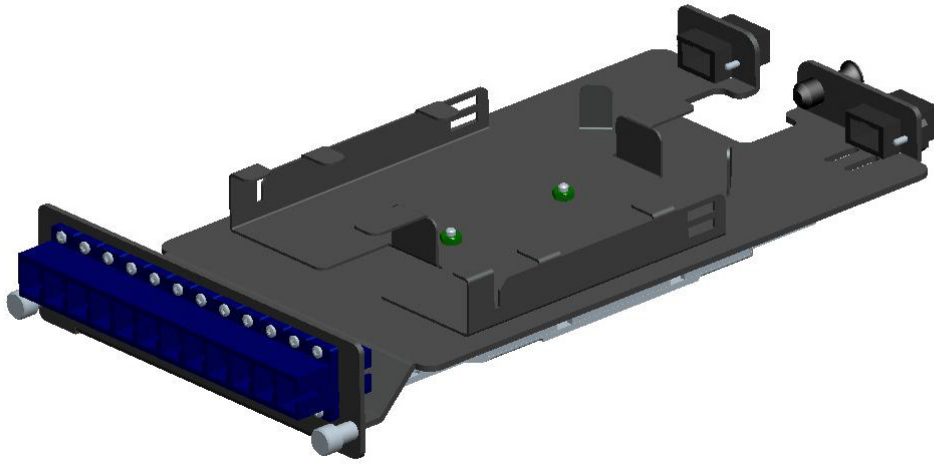

MTP® is a registered trademark of US Conec Ltd